

INTERNAL HEXAGON UNIVERSAL CONNECTION

UNIVERSAL PROSTHETICS



CPS Conical Platform Switching



CONNESSIONE CPS RESISTA

La connessione esagonale interna CPS prevede un doppia possibilità di protesizzazione che meglio si adatta alle differenti scuole di pensiero protesico.

- 1 La piattaforma esterna piana (flat to flat) è ideale per le soluzioni protesiche multi-impianto solidarizzate ed avvitate (tipo Toronto).
- 2 La piattaforma interna conica 45° (platform switching) è ideale per le soluzioni protesiche singole avvitate testa impianto o cementate su abutment singoli/multipli (ponti e corone).

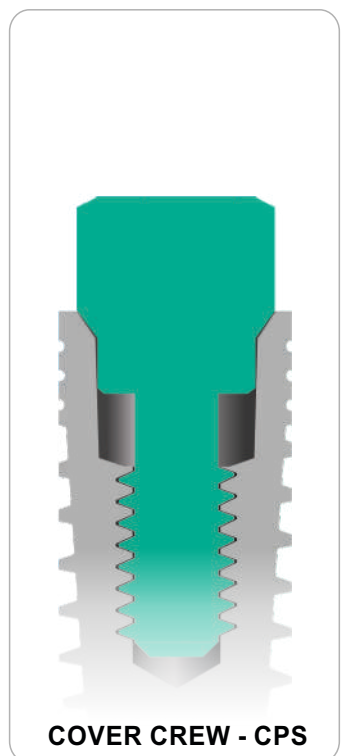
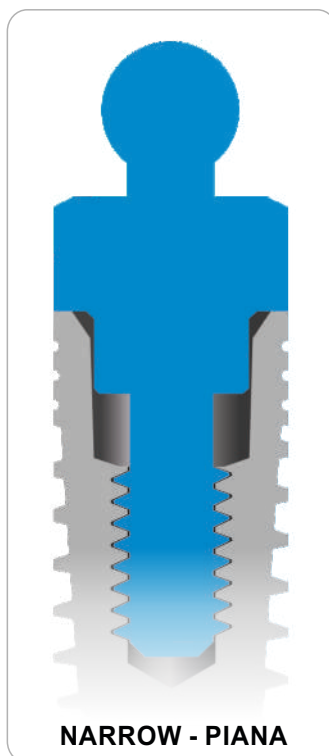
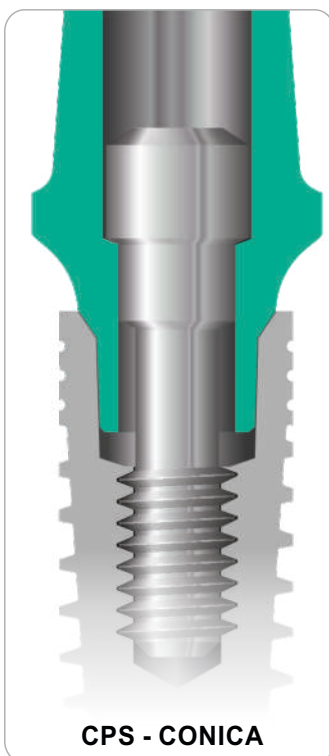
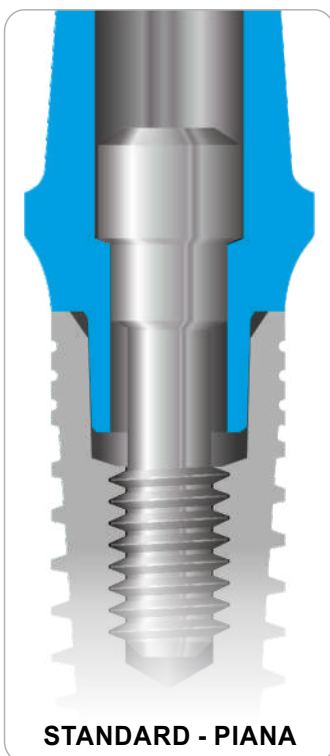
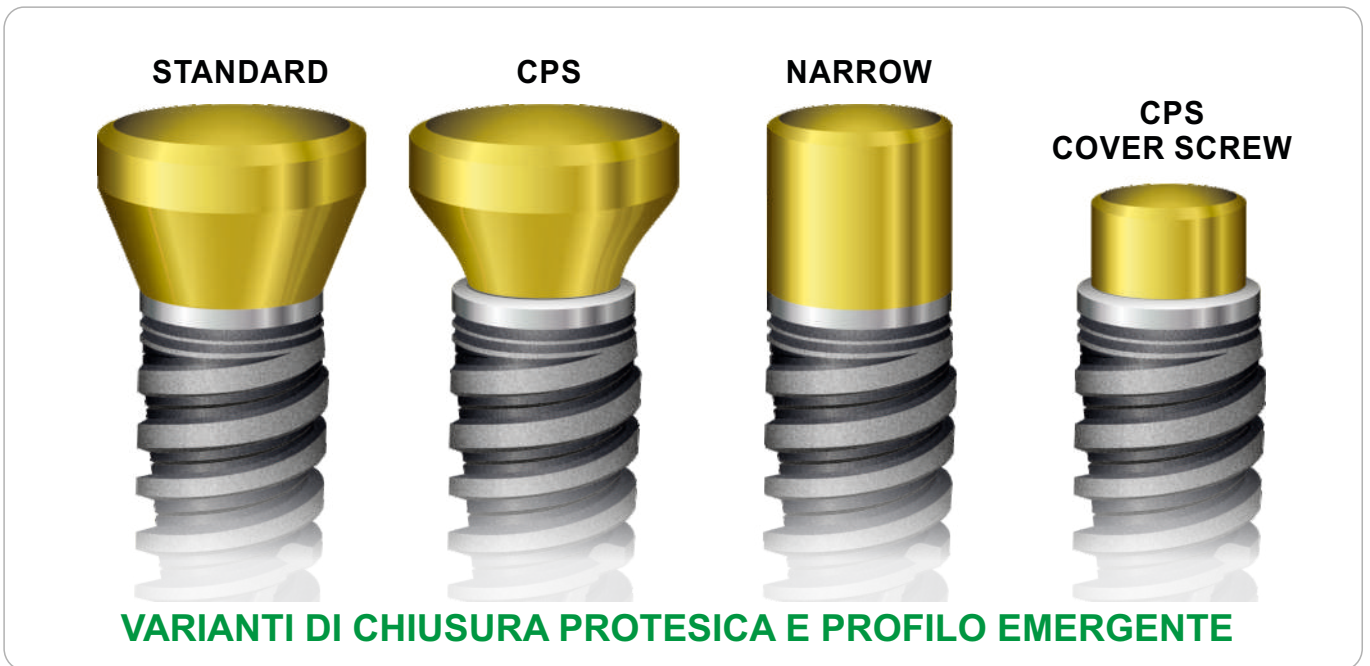

universal prosthetics

20Ncm 



Pilastro di Guarigione - Titanio Gr. 5 - Anodizzato
Healing Abutment - Titanium Gr. 5 - Anodized

- IP 4HA2-W** H 2 mm - **CPS** Standard Gingival Profile
- IP 4HA4-W** H 4 mm - **CPS** Standard Gingival Profile
- IP 4HA6-W** H 6 mm - **CPS** Standard Gingival Profile

DM 1/2 [Standard Hexagonal Driver](#)

20Ncm 



Pilastro di Guarigione - Titanio Gr. 5 - Anodizzato
Healing Abutment - Titanium Gr. 5 - Anodized

- IP 4HA2** H 2 mm - Standard Gingival Profile
- IP 4HA4** H 4 mm - Standard Gingival Profile
- IP 4HA6** H 6 mm - Standard Gingival Profile

DM 1/2 [Standard Hexagonal Driver](#)



Analogo per Laboratorio - Titanio Gr. 5 - Anodizzato
Laboratory Analog - Titanium Gr. 5 - Anodized

- IP 4AL** H 12 mm - Universal Shape

10Ncm 

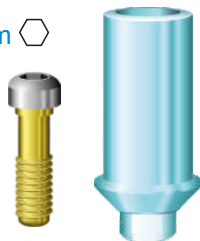

Moncone Calcinabile CPS - Acrilico
CPS Castable Abutment - Acrylic

- IP 4CA-W** Antirotation Hex - **CPS** Standard Gingival Profile
- IP 4CR-W** Rotating - **CPS** Standard Gingival Profile

IP VITG Vite di Ricambio Gold - Gold Spare Screw
DM 1/2 [Standard Hexagonal Driver](#)

10Ncm 



Moncone Calcinabile - Acrilico
Castable Abutment - Acrylic

- IP 4CA** Antirotation Hex - Standard Gingival Profile
- IP 4CR** Rotating - Standard Gingival Profile

IP VITG Vite di Ricambio Gold - Gold Spare Screw
DM 1/2 [Standard Hexagonal Driver](#)

universal prosthetics

Pilastro Temporaneo da Incollaggio - Titanio Gr. 5

Temporary Glueing Abutment - Titanium Gr. 5

IP 4TA-W Antirotation Hex - **CPS** Standard Gingival Profile

IP 4TR-W Rotating - **CPS** Standard Gingival Profile

IP VITG Vite di Ricambio Gold - Gold Spare Screw

DM 1/2 Standard Hexagonal Driver



Pilastro Temporaneo da Saldatura - Titanio Gr. 5

Temporary Welding Abutment - Titanium Gr. 5

IP 4TR-S Rotating - **CPS** Standard Gingival Profile

IP VITG Vite di Ricambio Gold - Gold Spare Screw

DM 1/2 Standard Hexagonal Driver



Moncone Provvisorio Estetico - PEEK Medica

Aesthetic Temporary Abutment - Medical PEEK

IP 4PA Antirotation Hex - Standard Gingival Profile

IP VITG Vite di Ricambio Gold - Gold Spare Screw

DM 1/2 Standard Hexagonal Driver

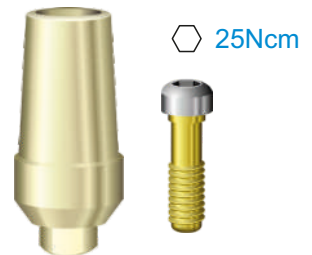

Pilastro per Overdenture - Titanio Gr. 5 - PVD TiN

Overdenture Abutment - Titanium Gr. 5 - PVD TiN

IP 4BA1-W H 1 mm - **CPS** Standard Gingival Profile - NORMO

IP 4BA2-W H 2 mm - **CPS** Standard Gingival Profile - NORMO

IP 4BA3-W H 3 mm - **CPS** Standard Gingival Profile - NORMO

IP 4BA4-W H 4 mm - **CPS** Standard Gingival Profile - NORMO

IP 4BA6-W H 6 mm - **CPS** Standard Gingival Profile - NORMO



Pilastro per Overdenture Equator - Titanio Gr. 5 - PVD TiN

Equator Overdenture Abutment - Titanium Gr. 5 - PVD TiN

IP 4EQ1 H 1 mm - Narrow Gingival Profile

IP 4EQ2 H 2 mm - Narrow Gingival Profile

IP 4EQ3 H 3 mm - Narrow Gingival Profile

IP 4EQ4 H 4 mm - Narrow Gingival Profile

IP 4EQ5 H 5 mm - Narrow Gingival Profile

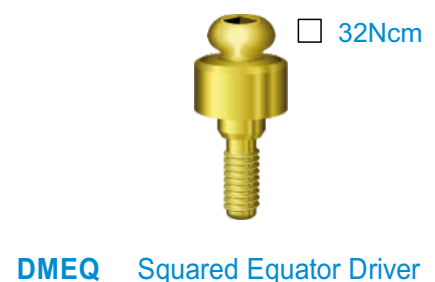

32Ncm 

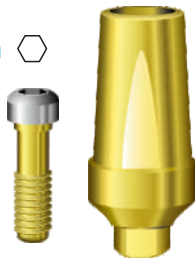

Moncone Titanio Diritto - Titanio Gr. 5 - PVD TiN

Straight Titanium Abutment - Titanium Gr. 5 - PVD TiN

IP 4ST2-W 0° - Straight - **CPS** Standard Gingival Profile

IP VITG Vite di Ricambio Gold - Gold Spare Screw
DM 1/2 Standard Hexagonal Driver

32Ncm 

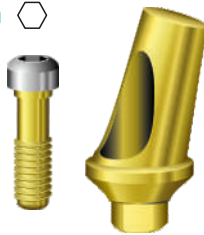

Moncone Titanio Angolato - Titanio Gr. 5 - PVD TiN

Angled Titanium Abutment - Titanium Gr. 5 - PVD TiN

IP 4AT15-W 15° - Angled - **CPS** Standard Gingival Profile

IP 4AT25-W 25° - Angled - **CPS** Standard Gingival Profile

IP VITG Vite di Ricambio Gold - Gold Spare Screw
DM 1/2 Standard Hexagonal Driver

32Ncm 



Moncone Titanio Diritto VPT - Titanio Gr. 5

VPT Straight Titanium Abutment - Titanium Gr. 5

IP 4STV-W 0° - Straight - **CPS** Standard Gingival Profile

Vertical Preparation Technique

IP VIT Vite di Ricambio - Spare Screw
DM 1/2 Standard Hexagonal Driver

32Ncm 

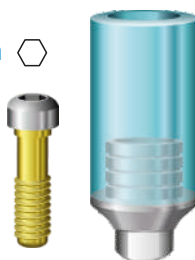

Moncone UCLA Cobalto Cromo - CoCr

UCLA Abutment Cobalt Chrome - CoCr

IP 4CCA Antirotation Hex - Standard Gingival Profile

IP 4CCA-W Antirotation Hex - **CPS** Standard Gingival Profile

IP 4CCR-W Rotating Hex - **CPS** Standard Gingival Profile

Intervallo di Fusione 1350°-1430°

Espansione Termica 13,3 - 13,6 µm/(m°C) (20°-200°)

32Ncm 

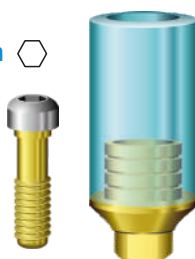

Moncone Ucla Oro - Base Oro/Platino/Iridio

Ucla Gold Abutment - Gold/Platinum/Iridium Base

IP 4GA Antirotation Hex - Standard Gingival Profile

IP VITG Vite di Ricambio Gold - Gold Spare Screw
DM 1/2 Standard Hexagonal Driver

universal prosthetics

Link per Incollaggio TiB - Titanio Gr. 5

Bonding Technique Link TiB - Titanium Gr. 5

- IP 4STB Link in Titanio Antirotazione - Compatibile TiB
- IP 4STB-W Link in Titanio Antirotazione **CPS** - Compatibile TiB

- IP VIT Vite di Ricambio - Spare Screw
- DM 1/2 Standard Hexagonal Driver



Link per Incollaggio Standard - Titanio Gr. 5

Bonding Technique Standard Link - Titanium Gr. 5

- IP 4SZB Link in Titanio Antirotazione - Non compatibile TiB

- IP VIT Vite di Ricambio - Spare Screw
- DM 1/2 Standard Hexagonal Driver



Monconi Estetici - Zirconia + Link in Titanio Gr. 5

Titanium Abutment - Zirconium + Titanium Gr. 5 Link

- IP 4SZ 0° - Straight - Standard Gingival Profile
- IP 4AZ15 15° - Angled - Standard Gingival Profile

- IP VITG Vite di Ricambio Gold - Gold Spare Screw
- DM 1/2 Standard Hexagonal Driver



Transfer per impronta Pick Up - Titanio Gr. 5

Pick Up Impression Coping - Titanium Gr. 5

- IP X40-W H 12mm - Internal Hexagon CPS
- DM 1/2 Standard Hexagonal Driver

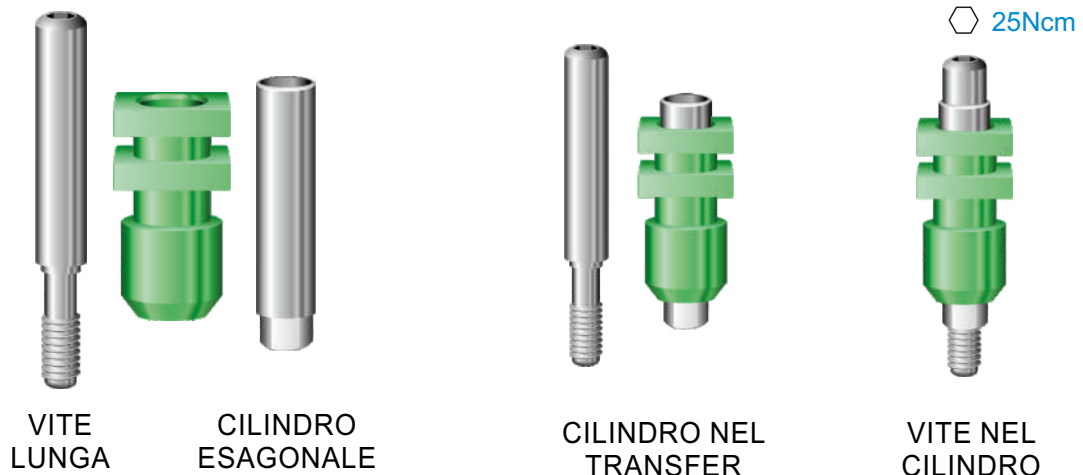

Transfer per Impronta Digitale - Titanio Gr. 5 + MS
Scan Abutment - Titanium Gr. 5 + Micro Sandblasting

25Ncm 



IP 4SA DS Antirotation Hex - **Narrow** Gingival Profile

DM 1/2 Standard Hexagonal Driver

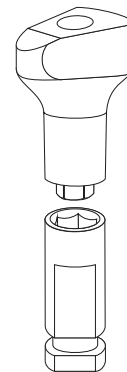
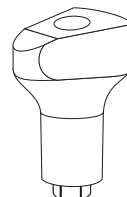

Scansione

Matematiche

Matching delle Matematiche

Link Base per Incollaggio - Titanio Gr. 5

Bonding Technique Base Link - Titanium Gr. 5

32Ncm 



← H 3
 ← H 2
 ← H 1

IP 4TB DS Antirotation Hex - Adjustable in 3 heights

H1 = 4.0mm - H2 = 5.5mm - H3 = 7.0mm

IP VITG Vite di Ricambio Gold - Gold Spare Screw

DM 1/2 Standard Hexagonal Driver

Link Base per Incollaggio - Titanio Gr. 5

Bonding Technique Base Link - Titanium Gr. 5

32Ncm 



← H 3
 ← H 2
 ← H 1

IP 4TBR DS Rotating - Adjustable in 3 heights

H1 = 4.0mm - H2 = 5.5mm - H3 = 7.0mm

IP VITG Vite di Ricambio Gold - Gold Spare Screw

DM 1/2 Standard Hexagonal Driver

Analogo per Laboratorio - Titanio Gr. 5

Laboratory Analog - Titanium Gr. 5



IP 4AL DS H 10 mm - Ø 4 Universal Shape

IP 5AL DS H 10 mm - Ø 5 Universal Shape

toronto universal prosthetics

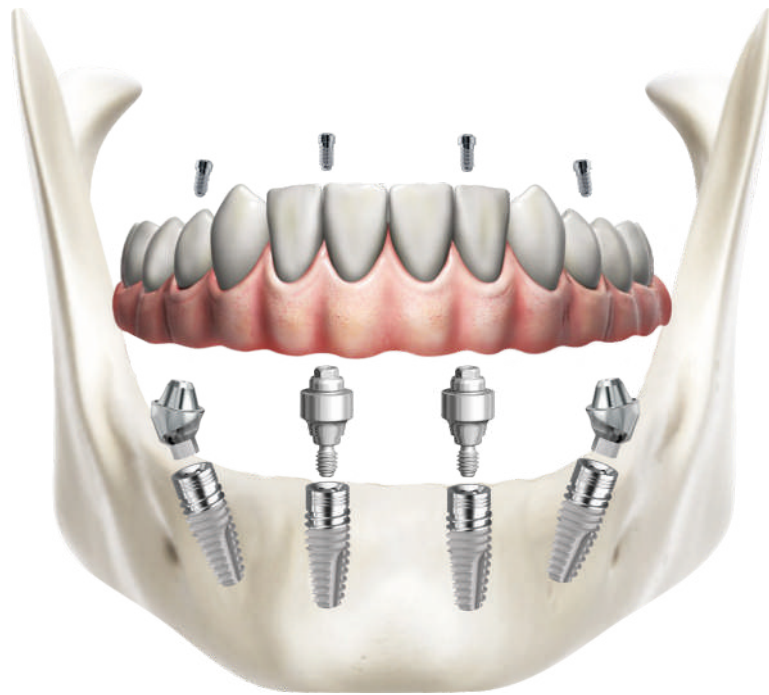

Pilastro Toronto Dritto - Titanio Gr. 5

Toronto Straight Abutment - Titanium Gr. 5

- IP MS1-W** H 1 mm - **CPS** Standard Gingival Profile
- IP MS2-W** H 2 mm - **CPS** Standard Gingival Profile
- IP MS3-W** H 3 mm - **CPS** Standard Gingival Profile

DCDM Toronto Straight Abutment Driver



Pilastro Toronto Angolato 17° - Titanio Gr. 5

17° Toronto Angled Abutment - Titanium Gr. 5

- IP MA172-W** 17° - H 2 mm - **CPS** Standard Gingival Profile
- IP MA173-W** 17° - H 3 mm - **CPS** Standard Gingival Profile

IP VITMA Vite di Ricambio Toronto - Toronto Spare Screw

DMX 1/2 Toronto Abutment Torx Driver



Pilastro Toronto Angolato 30° - Titanio Gr. 5

30° Toronto Angled Abutment - Titanium Gr. 5

- IP MA303-W** 30° - H 3 mm - **CPS** Standard Gingival Profile
- IP MA304-W** 30° - H 4 mm - **CPS** Standard Gingival Profile
- IP MA305-W** 30° - H 5 mm - **CPS** Standard Gingival Profile

IP VITMA Vite di Ricambio Toronto - Toronto Spare Screw

DMX 1/2 Toronto Abutment Torx Driver





Pilastro Temporaneo Toronto - Titanio Gr. 5

Toronto Temporary Abutment - Titanium Gr. 5

EP MT Rotating - Bonding Technique - Incollaggio Passivo

EP MV Vite di Ricambio Toronto - Toronto Spare Screw

DMX 1/2 Toronto Abutment Torx Driver



Pilastro Temporaneo Toronto - Titanio Gr. 5

Toronto Temporary Abutment - Titanium Gr. 5

EP MT-S Rotating - Welding Technique - Saldatura Intraorale

EP MV Vite di Ricambio Toronto - Toronto Spare Screw

DMX 1/2 Toronto Abutment Torx Driver



Pilastro Calcinabile Toronto - Acrilico

Toronto Castable Abutment - Acrylic

EP MC Rotating - Standard Gingival Profile

EP MV Vite di Ricambio Toronto - Toronto Spare Screw

DMX 1/2 Toronto Abutment Torx Driver



Pilastro di Guarigione Toronto - PE

Toronto Healing Abutment - PE

EP MHA H 4 mm - Standard Gingival Profile

EP MHA6 H 6 mm - Standard Gingival Profile

DMX 1/2 Toronto Abutment Torx Driver



Transfer Toronto - Titanio Gr. 5

Toronto Impression Coping - Titanium Gr. 5

EP MI Rotating - Standard Gingival Profile

EP MVL Vite di Ricambio Toronto L - Toronto L Spare Screw

DMX 1/2 Toronto Abutment Torx Driver

toronto universal prosthetics

Viti di Ricambio Toronto - Titanio Gr. 5

Toronto Spare Screws - Titanium Gr. 5

EP MV Prosthetic Spare Screw

EP MVL Impression Spare Screw

DMX 1/2 Toronto Abutment Torx Driver

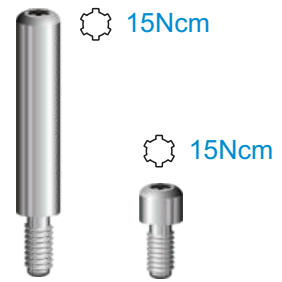

Analogo Toronto - Titanio Gr. 5

Toronto Analog - Titanium Gr. 5

EP MAL H 10 mm - Universal Shape



CPS Cover Screw - Potenza GBR e GTR

GTR - Incremento di gengiva aderente



GBR - Recupero facilitato della Cover Screw

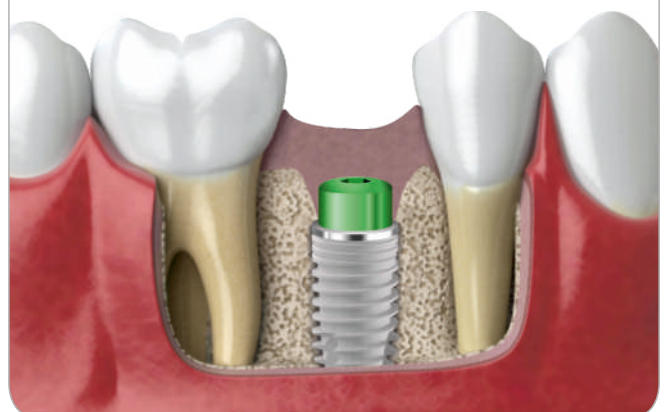

Vite Chirurgica di Copertura CPS - Titanio Gr. 4

CPS Cover Screw - Titanium Gr. 4

IP 4CS1 CPS Cover Screw - 1.5mm

IP 4CS3 CPS Cover Screw - 3.0mm

IP 4CS5 CPS Cover Screw - 5.0mm

DM 1/2 Standard Hexagonal Driver





Transfer Toronto per Impronta Digitale - Titanio Gr. 5
Toronto Scan Abutment - Titanium Gr. 5

15Ncm 

EP MSA DS Rotating Scan Abutment - Transfer Digitale Rotante

EP MV Vite di Ricambio Toronto - Toronto Spare Screw
DMX 1/2 Toronto Abutment Torx Driver



Link Base per Incollaggio - Titanio Gr. 5
Bonding Technique Base Link - Titanium Gr. 5

15Ncm 

EP MT DS Rotating - Bonding Technique - Incollaggio Passivo

EP MV Vite di Ricambio Toronto - Toronto Spare Screw
DMX 1/2 Toronto Abutment Torx Driver



Analogo Toronto per Laboratorio - Titanio Gr. 5
Laboratory Toronto Analog - Titanium Gr. 5

EP MAL DS Universal Toronto Analog

